



# Screw Air Compressor

Tianjin Jinjing Gas Compressor Manufacturing Co.,Ltd.





# Our Company

## 01

Tianjin Jinjing Gas Compressor Manufacturing Co.,Ltd.



Tianjin Jinjing Gas Compressor Manufacturing Co.,Ltd. founded in 2005, is a leading high technology of machine and equipment manufacturer integrating the design, R&D, production, sales and service for air compressors & Mining Equipment. Adopting advanced technology, design concept and quality control, and we are able to provide customized products to meet customers' OEM needs.

Our company has more than 520 employees, including 86 senior technicians and professional engineers. Our technical team provides our customers with professional air system solutions. With the total 15000 square meters of the facility, four modern advanced production lines are built up to ensure production capacity to meet customer requirements.

Our company has been awarded the honorary title of "Tianjin high-tech enterprise" and our products enjoy high honors in the industry. Our company has the ISO9001 certification and was awarded the qualification certificate of equipment through military contracts in 2018.

We have a complete system of after-sales service and quality assurance. The company's material purchase, inspection, manufacturing, installation, and testing are strictly in accordance with the ISO procedures. which will ensure each compressor has reliable quality and has a complete record to trace, if needed.

**2005**  
Founded

**15000**  
Square Meters

**16**  
Years





# 02 Honor Certificate





# Contents

## Our Exhibition

### 03

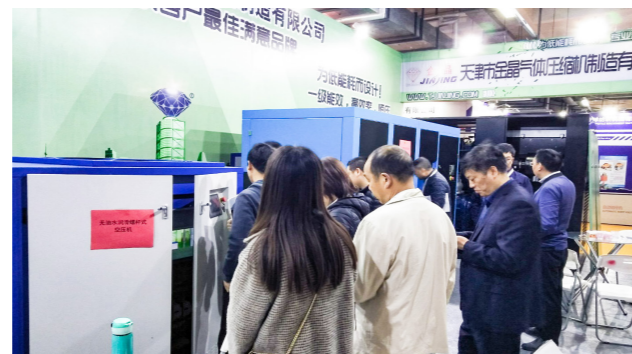
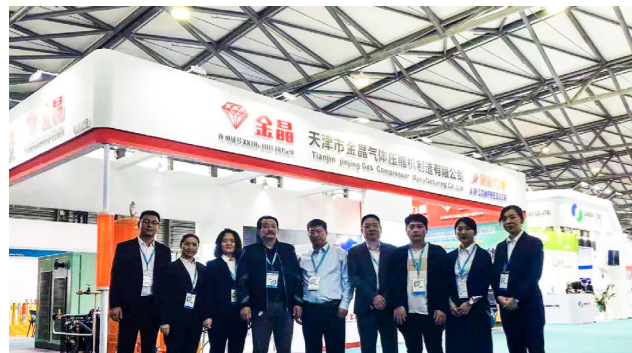

Fix Speed Screw Air Compressor	01
VSD Screw Air Compressor	06
PM VSD Screw Air Compressor	11
Low Pressure PM VSD Screw Air Compressor	16
Medium Pressure Screw Air Compressor	21
Two Stage Compression Screw Air Compressor	23
Four in One Integrated Screw Air Compressor	31
Screw Air Compressor for Laser Cutting	33
Oil Cooled PM VSD Air Compressor	36
Water Lubricated Oil-free Screw Air Compressor	40
Dry Oil-free Screw Air Compressor	46
Maglev Blower	48
Oil Free Turbo Air Compressor	52
Jinjing Compressor Tips	54



# Screw Air Compressor

Screw air compressor provide reliable and high-quality compressed air supply for the production process in numerous industrial, trade and workshop applications. They are the first choice for users who need to maintain constant pressure for a long time.

In order to ensure that our screw compressor operates as efficiently as possible, Jinjing has independently developed its own special rotor profile. Compared with other traditional rotor profile designs, Jinjing rotor can save up to 15% energy.

Our precision machined large-size roller bearings help to make our air end have a long service life. All these, together with our state-of-the-art internal manufacturing processes and strict manufacturing tolerances, provide excellent quality synonymous with the Jinjing name.

## Five advantages of Jinjing screw air compressor

- Unique Design
- Larger Air Delivery
- Longer Operating Life
- Higher Efficiency
- Lower Rotation Speed

## Fix Speed Screw Air Compressor



### Structure



#### Intelligent controller

- Higher reliability: durable keyboard, user-friendly multilingual user interface
- Improve ease of use: intuitive navigation system conditions with main operations, including warning instructions, maintenance plans, etc.



#### Intelligent control and protection

- Jinjing electrical elements are safe and reliable.
- The wiring is reasonable, simple and easy to maintain.
- Good protection function ensures stable operation of compressor unit.



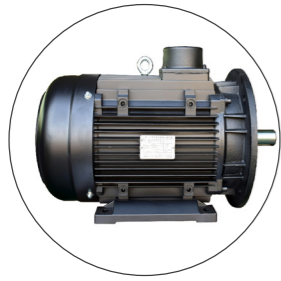

## High efficiency motor

- High efficiency totally enclosed fan cooling IP54 / IP55 motor (Class F insulation) to prevent dust and chemicals.
- It can operate stably for a long time even in harsh environment, up to 55 °C (131 °F).

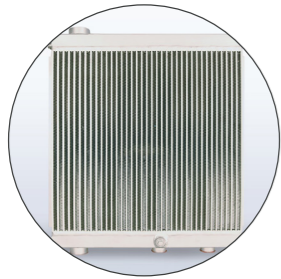

## Efficient radiator

- High quality aluminum fins and copper coils with good thermal conductivity ensure perfect cooling efficiency

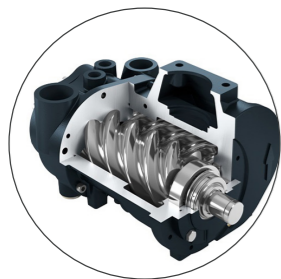

## The most advanced screw elements

- Screw air end originally imported from Germany
- Advanced SAP configuration file design
- Rotor material is American special steel
- Advanced Swedish SKF element bearing

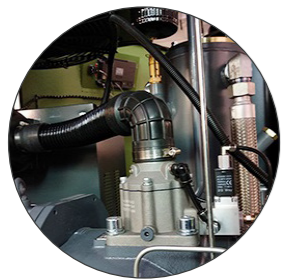

## Stainless steel oil pipe and air pipe

- High temperature resistance (400 °C = 752 °F ), low temperature resistance (- 270 °C = - 518 °F ), high pressure resistance.
- Ultra long service life (80 years), completely leak free and maintenance free.

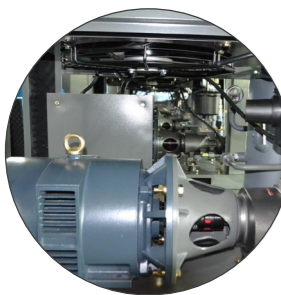

## Energy saving 1:1 direct drive design

- German brand maintenance free coupling enables the motor to drive the air end without transmission loss.

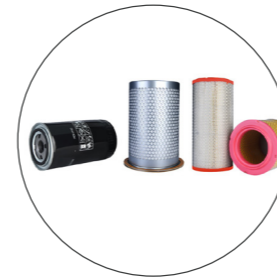

## High quality accessories

- Oil filter: excellent oil quality and purification capacity, ensures the cleanness and safety of the oil system. Long service life, easy replacement of filter element and low maintenance cost.
- Air filter: advanced air filter, with high efficiency of two-stage dust removal and filtration system, which can reach 99.9% even in heavy environment. Extend the service life of compressor elements and elements to ensure high air quality.



## Efficient separation system

- Reduce pressure drop and energy cost
- Low oil consumption to ensure minimum maintenance cost and long service life of compressor
- High quality air with low oil content: three-step oil-gas separation (centrifugal, gravity and filtration)

### Parameter

Model	Pressure (mpa)	Displacement (m³/min)	Power (kw)	Dimension (mm)	Weight (kg)	Outlet Size
FSS-0.7/7.5	0.7	1.20	7.5	900*650*950	450	G3/4"
FSS-0.8/7.5	0.8	1.10				
FSS-1.0/7.5	1.0	0.95				
FSS-1.3/7.5	1.3	0.80				
FSS-0.7/11	0.7	1.70	11	1150*750*1020	500	G1"
FSS-0.8/11	0.8	1.60				
FSS-1.0/11	1.0	1.40				
FSS-1.3/11	1.3	1.20				
FSS-0.7/15	0.7	2.40	15	1150*750*1020	550	G1"
FSS-0.8/15	0.8	2.20				
FSS-1.0/15	1.0	2.00				
FSS-1.3/15	1.3	1.70				
FSS-0.7/18.5	0.7	3.10	18.5	1300*850*1140	580	Rp1-1/4"
FSS-0.8/18.5	0.8	2.90				
FSS-1.0/18.5	1.0	2.70				
FSS-1.3/18.5	1.3	2.20				
FSS-0.7/22	0.7	3.80	22	1300*850*1140	620	Rp1 1/4"
FSS-0.8/22	0.8	3.50				
FSS-1.0/22	1.0	3.20				
FSS-1.3/22	1.3	2.90				





Model	Pressure (mpa)	Displacement (m <sup>3</sup> /min)	Power (kw)	Dimension (mm)	Weight (kg)	Outlet Size
FSS-0.7/30	0.7	5.20	30	1300*850*1150	950	Rp1 1/4"
FSS-0.8/30	0.8	5.00				
FSS-1.0/30	1.0	4.30				
FSS-1.3/30	1.3	3.70				
FSS-0.7/37	0.7	6.40	37	1500*950*1230	1020	Rp1 1/2"
FSS-0.8/37	0.8	6.10				
FSS-1.0/37	1.0	5.70				
FSS-1.3/37	1.3	5.00				
FSS-0.7/45	0.7	8.00	45	1500*950*1230	1050	Rp1 1/2"
FSS-0.8/45	0.8	7.70				
FSS-1.0/45	1.0	7.00				
FSS-1.3/45	1.3	5.80				
FSS-0.7/55	0.7	10.50	55	1800*1250*1600	1500	Rp2"
FSS-0.8/55	0.8	9.80				
FSS-1.0/55	1.0	8.70				
FSS-1.3/55	1.3	7.60				
FSS-0.7/75	0.7	13.60	75	1950*1250*1650	1600	Rp2"
FSS-0.8/75	0.8	13.30				
FSS-1.0/75	1.0	11.60				
FSS-1.3/75	1.3	9.80				
FSS-0.7/90	0.7	16.30	90	2020*1250*1650	1800	Rp2"
FSS-0.8/90	0.8	16.00				
FSS-1.0/90	1.0	14.60				
FSS-1.3/90	1.3	12.30				
FSS-0.7/110	0.7	20.30	110	2460*1500*1800	4000	DN65
FSS-0.8/110	0.8	19.40				
FSS-1.0/110	1.0	17.30				
FSS-1.3/110	1.3	14.60				
FSS-0.7/132	0.7	24.00	132	2460*1500*1800	4500	DN65
FSS-0.8/132	0.8	23.00				
FSS-1.0/132	1.0	20.00				
FSS-1.3/132	1.3	18.00				
FSS-0.7/160	0.7	28.00	160	2580*1600*1980	4800	DN65
FSS-0.8/160	0.8	26.50				
FSS-1.0/160	1.0	22.50				
FSS-1.3/160	1.3	20.10				
FSS-0.7/185	0.7	32.50	185	2800*1700*2030	5200	DN65
FSS-0.8/185	0.8	31.00				
FSS-1.0/185	1.0	28.00				
FSS-1.3/185	1.3	25.10				

Model	Pressure (mpa)	Displacement (m <sup>3</sup> /min)	Power (kw)	Dimension (mm)	Weight (kg)	Outlet Size
FSS-0.7/200	0.7	35.00	200	3100*1700*2100	5500	DN80
FSS-0.8/200	0.8	34.00				
FSS-1.0/200	1.0	32.00				
FSS-1.3/200	1.3	26.50				
FSS-0.7/220	0.7	40.00	220	3100*1700*2100	5800	DN80
FSS-0.8/220	0.8	36.80				
FSS-1.0/220	1.0	32.20				
FSS-1.3/220	1.3	28.50				
FSS-0.7/250	0.7	43.50	250	3400*2000*2100	6200	DN100
FSS-0.8/250	0.8	42.00				
FSS-1.0/250	1.0	38.10				
FSS-1.3/250	1.3	34.60				
FSS-0.7/315	0.7	50.80	315	5010*2210*2130	8000	DN125
FSS-0.8/315	0.8	48.20				
FSS-1.0/315	1.0	42.60				
FSS-1.3/315	1.3	39.80				
FSS-0.7/355	0.7	60.00	355	5200*2500*2130	8500	DN125
FSS-0.8/355	0.8	57.00				
FSS-1.0/355	1.0	50.00				
FSS-1.3/355	1.3	45.00				

1. Displacement in accordance with ISO 1217 : 2009.

2. Noise level as per ISO 2151 and the basic standard ISO 9614-2, operation at maximum operating pressure and maximum speed; tolerance: ± 3 dB(A).

Notice: Specifications are subject to change without notice.





# VSD Screw Air Compressor



## Introduction

Jinjing adopts international advanced frequency conversion module, special motor with speed up and down characteristics, and a set of PID parameters especially suitable for screw compressor. The control software has been tested by hundreds of thousands of compressors, with simple parameter setting and friendly man-machine interface. The cooling of frequency converter is specially designed. In order to support the user to set the best working pressure, the filtering area of the filter element of the oil-gas separator is increased.

The exhaust volume of Jinjing variable speed screw air compressor can be perfectly combined with the user's air consumption, completely avoiding the loss of unloading power; Under the condition of intermittent gas consumption, the zero load effect of soft start avoids the peak value of current and torque, so the unit can start and stop indefinitely.

## Structure



### Variable speed drive

- Variable volume, controlled costs: there is no unnecessary power generated, the Jinjing VSD models can reduce energy costs by 35% or more.
- Life cycle costs of the compressor can be reduced by an average of 20%.

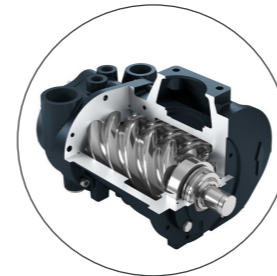

### State-of-the-art screw element

- Original Jinjing air end
- Advanced profile design
- The material of rotor is special steel
- Superior Sweden element bearings



### Intelligent controller

- Increased reliability: durable keyboard, user-friendly, multilingual user interface.
- Improved ease of use: intuitive navigation system with main operation conditions include warning indications, maintenance scheduling etc.



### Intelligent control and protection

- Jinjing electrical elements are safe and reliable
- Reasonable, simple and clear wiring, easy for maintenance
- Good protection function ensures the stable running of the compressor unit

Screw Air Compressor





### Stainless steel oil pipe and air pipe

- High temperature resistance (400 °C = 752 °F ), low temperature resistance (- 270 °C = - 518 °F ), high pressure resistance.
- Ultra long service life (80 years), completely leak free and maintenance free.



### High quality accessories

- Oil filter: excellent oil quality and purification capacity, ensures the cleanness and safety of the oil system. Long service life, easy replacement of filter element and low maintenance cost.
- Air filter: advanced air filter, with high efficiency of two-stage dust removal and filtration system, which can reach 99.9% even in heavy environment. Extend the service life of compressor elements and elements to ensure high air quality.



### Efficient separation system

- Reduce pressure drop and energy cost
- Low oil consumption to ensure minimum maintenance cost and long service life of compressor
- High quality air with low oil content: three-step oil-gas separation (centrifugal, gravity and filtration)

## Difference between variable speed screw air compressor and fix speed screw air compressor

### Stable air pressure

- ① Because the variable speed screw air compressor uses the stepless speed regulation characteristics of the frequency converter, it can start smoothly through the controller or the PID regulator inside the frequency converter; In case of large fluctuation of gas consumption, it can quickly adjust the response.
- ② Compared with the upper and lower limit switch control of fix speed operation, the air pressure stability is improved exponentially.

### Starting without impact

- ① Since the frequency converter itself includes the function of soft starter, the starting current is large, which is less than 1.2 times of the rated current. Compared with fix speed starting, which is generally more than 6 times of the rated current, the starting impact is very small
- ② This impact is not only to the power grid, but also to the whole mechanical system, but also greatly reduced.

### Variable flow control

- ① The fix speed driven air compressor can only work at one exhaust volume, and the variable speed air compressor can work at a wide exhaust volume. The frequency converter adjusts the motor speed according to the actual air consumption to control the exhaust volume.
- ② When the air consumption is low, the air compressor can sleep automatically, which greatly reduces the loss of energy.

### The voltage adaptability of AC power supply is better

- ① The frequency converter adopts over modulation technology, which can still output enough torque to drive the motor when the AC power supply voltage is slightly low; When the voltage is slightly higher, the voltage output to the motor will not be too high.
- ② For self generating occasions, variable speed drive can better show its advantages.
- ③ According to the characteristics of motor VF (the variable speed air compressor works below the rated voltage in the energy-saving state), the effect is obvious for the site with low grid voltage.

### Parameter

Model	Pressure (mpa)	Displacement (m³/min)	Power (kw)	Dimension (mm)	Weight (kg)	Outlet Size
VSD-0.7/7.5	0.7	1.20	7.5	840*620*850	450	G3/4"
VSD-0.8/7.5	0.8	1.10				
VSD-1.0/7.5	1.0	0.95				
VSD-1.3/7.5	1.3	0.80				
VSD-0.7/11	0.7	1.70	11	1150*750*1020	500	G1"
VSD-0.8/11	0.8	1.60				
VSD-1.0/11	1.0	1.40				
VSD-1.3/11	1.3	1.20				





Model	Pressure (mpa)	Displacement (m <sup>3</sup> /min)	Power (kw)	Dimension (mm)	Weight (kg)	Outlet Size
VSD-0.7/15	0.7	2.40	15	1150*750*1020	550	G1"
VSD-0.8/15	0.8	2.20				
VSD-1.0/15	1.0	2.00				
VSD-1.3/15	1.3	1.70				
VSD-0.7/22	0.7	3.80	22	1300*850*1140	620	Rp1 1/4"
VSD-0.8/22	0.8	3.50				
VSD-1.0/22	1.0	3.20				
VSD-1.3/22	1.3	2.90				
VSD-0.7/37	0.7	6.40	37	1500**950*1230	1020	Rp1 1/2"
VSD-0.8/37	0.8	6.10				
VSD-1.0/37	1.0	5.70				
VSD-1.3/37	1.3	5.00				
VSD-0.7/45	0.7	8.00	45	1500**950*1230	1050	Rp1 1/2"
VSD-0.8/45	0.8	7.70				
VSD-1.0/45	1.0	7.00				
VSD-1.3/45	1.3	5.80				
VSD-0.7/55	0.7	10.50	55	1800*1250*1600	1500	Rp2"
VSD-0.8/55	0.8	9.80				
VSD-1.0/55	1.0	8.70				
VSD-1.3/55	1.3	7.60				
VSD-0.7/75	0.7	13.60	75	1950*1250*1650	1600	Rp2"
VSD-0.8/75	0.8	13.30				
VSD-1.0/75	1.0	11.60				
VSD-1.3/75	1.3	9.80				
VSD-0.7/90	0.7	16.30	90	2020*1250*1650	1800	DN65
VSD-0.8/90	0.8	16.00				
VSD-1.0/90	1.0	14.60				
VSD-1.3/90	1.3	12.30				
VSD-0.7/110	0.7	20.30	110	2460*1500*1800	4000	DN65
VSD-0.8/110	0.8	19.40				
VSD-1.0/110	1.0	17.30				
VSD-1.3/110	1.3	14.60				
VSD-0.7/132	0.7	24.00	132	2460*1500*1800	4500	DN65
VSD-0.8/132	0.8	23.00				
VSD-1.0/132	1.0	20.00				
VSD-1.3/132	1.3	18.00				
VSD-0.7/160	0.7	28.00	160	2580*1600*1980	4800	DN65
VSD-0.8/160	0.8	26.50				
VSD-1.0/160	1.0	22.50				
VSD-1.3/160	1.3	20.10				
VSD-0.7/185	0.7	32.50	185	2800*1700*2030	5200	DN65
VSD-0.8/185	0.8	31.00				
VSD-1.0/185	1.0	28.00				
VSD-1.3/185	1.3	25.10				
VSD-0.7/250	0.7	43.50	250	3400*2000*2100	6200	DN100
VSD-0.8/250	0.8	42.00				
VSD-1.0/250	1.0	38.10				
VSD-1.3/250	1.3	34.60				

The best balance between performance and input  
**PM VSD Screw Air Compressor**



**Introduction**

At present, the effective energy consumption of the air compressor system only accounts for 66%, and the remaining 34% of the energy is wasted in vain. The serious waste of energy consumption is shocking. The energy saving of the air compressor system urgently needs to be carried out efficiently.

On the other hand, in addition to requiring air compressors to be more environmentally friendly, energy-saving and efficient, corporate users also expect to ensure high performance while optimizing costs. This is also the focus of Jinjing's focus on launching permanent magnet variable frequency air compressors.

Permanent magnet variable speed screw air compressor is a necessary equipment for every factory now, and it also consumes a lot of power during operation. Therefore, energy-saving air compressor should be selected when purchasing, so as to truly realize energy conservation and emission reduction.





## Structure



### Permanent magnet motor

- Synchronous motor with permanent magnet and frequency converter without any bearing, elastic coupling or sealing washer.
- Eliminate wear, leakage and replacement.



### Variable speed drive

- Variable capacity, controlled cost.
- The life cycle cost of the compressor can be reduced by 22% on average.

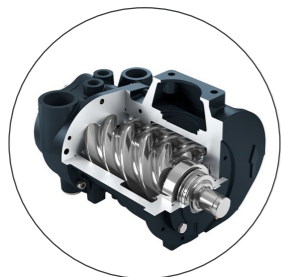

### State of the art screw components

- The material of rotor is special steel.
- Advanced wear resistant bearings.
- The rotating screw comes standard with oversized to achieve the highest efficiency.



### Intelligent controller

- Increased reliability: durable keyboard, user-friendly, multilingual user interface.
- Improved ease of use: intuitive navigation system with main operation conditions include warning indications, maintenance scheduling etc.



### Centrifugal fan

- Low speed centrifugal fan specially used for oil cooler and air cooler. Separate fans maintain the optimum temperature of oil and air while producing extremely low noise levels.

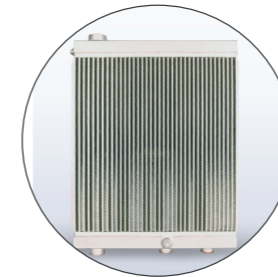

### Cooler

- The size of the cooler is too large to ensure the best operating temperature under any environmental conditions. Easy to place and clean.



### Efficient separation system

- Reduce pressure drop and energy cost
- Low oil consumption to ensure minimum maintenance cost and long service life of compressor
- High quality air with low oil content: three-step oil-gas separation (centrifugal, gravity and filtration)
- Oil content: less than 3 ppm by weight; The hinged cover facilitates the replacement of separator elements.

## Advantages

### Low noise

- ① Most working conditions of the permanent magnet variable speed air compressor system are lower than the rated speed, the mechanical noise and wear of the main engine are reduced, and the maintenance and service life are prolonged.
- ② The fan also adopts frequency conversion drive to better reduce the noise of the air compressor.

### Variable flow control

The permanent magnet variable speed air compressor can work in a wide range of exhaust volume. The frequency converter adjusts the motor speed in real time according to the actual air consumption to control the exhaust volume.

### Start without impact

Since the frequency converter itself contains the function of a soft starter, the maximum starting current is within 1.2 times of the rated current, and the starting impact is small.





### Maintenance free

The permanent magnet variable speed air compressor adopts rare earth permanent magnet synchronous motor to directly drive the screw air end. It does not lose magnetism at 120 °C , has a service life of 10 years, and is durable.

### Good energy efficiency

At full load, the permanent magnet motor of the permanent magnet variable speed screw air compressor produces the maximum air volume under the minimum energy consumption.

### Barometric stability

Through the controller or the internal regulator of the frequency converter, the machine can be started smoothly, and the response can be adjusted quickly even when the air consumption fluctuates to ensure stable air pressure.

### Parameter

Model	Pressure (mpa)	Displacement (m³/min)	Power (kw)	Dimension (mm)	Weight (kg)	Outlet Size
PV-0.7/7.5	0.7	1.2	7.5	900*650*950	450	G3/4"
PV-0.8/7.5	0.8	1.1				
PV-1.0/7.5	1.0	0.95				
PV-1.3/7.5	1.3	0.8				
PV-0.7/11	0.7	1.7	11	1150*750*1020	500	G1"
PV-0.8/11	0.8	1.6				
PV-1.0/11	1.0	1.4				
PV-1.3/11	1.3	1.2				
PV-0.7/15	0.7	2.4	15	1150*750*1020	550	G1"
PV-0.8/15	0.8	2.2				
PV-1.0/15	1.0	2.0				
PV-1.3/15	1.3	1.7				
PV-0.7/22	0.7	4.2	22	1300*850*1140	620	Rp1 1/4"
PV-0.8/22	0.8	4.1				
PV-1.0/22	1.0	3.5				
PV-1.3/22	1.3	3.2				
PV-0.7/37	0.7	7.0	37	1500*950*1230	1020	Rp1 1/2"
PV-0.8/37	0.8	7.1				
PV-1.0/37	1.0	5.8				
PV-1.3/37	1.3	5.4				

Model	Pressure (mpa)	Displacement (m³/min)	Power (kw)	Dimension (mm)	Weight (kg)	Outlet Size
PV-0.7/45	0.7	9.8	45	1500*950*1230	1150	Rp1 1/2"
PV-0.8/45	0.8	9.7				
PV-1.0/45	1.0	7.8				
PV-1.3/45	1.3	6.5				
PV-0.7/55	0.7	12.2	55	1800*1250*1600	1500	Rp2"
PV-0.8/55	0.8	12.0				
PV-1.0/55	1.0	9.6				
PV-1.3/55	1.3	8.6				
PV-0.7/75	0.7	16.8	75	1950*1250*1650	1600	Rp2"
PV-0.8/75	0.8	16.5				
PV-1.0/75	1.0	12.5				
PV-1.3/75	1.3	11.2				
PV-0.7/90	0.7	19.8	90	2020*1250*1650	1800	Rp2"
PV-0.8/90	0.8	19.2				
PV-1.0/90	1.0	16.9				
PV-1.3/90	1.3	14.3				
PV-0.7/110	0.7	23.6	110	2460*1500*1800	2800	DN65
PV-0.8/110	0.8	23.1				
PV-1.0/110	1.0	19.7				
PV-1.3/110	1.3	17.6				
PV-0.7/132	0.7	30.0	132	2460*1500*1800	3000	DN65
PV-0.8/132	0.8	28.0				
PV-1.0/132	1.0	23.5				
PV-1.3/132	1.3	19.8				
PV-0.7/160	0.7	34.5	160	2900*2100*2300	3000	DN125
PV-0.8/160	0.8	33.6				
PV-1.0/160	1.0	30.0				
PV-1.3/160	1.3	28.3				
PV-0.7/185	0.7	41.0	185	2800*1700*2030	4300	DN65
PV-0.8/185	0.8	38.4				
PV-1.0/185	1.0	32.5				
PV-1.3/185	1.3	28.6				
PV-0.7/250	0.7	55.0	250	3400*2000*2100	4800	DN100
PV-0.8/250	0.8	54.0				
PV-1.0/250	1.0	46.0				
PV-1.3/250	1.3	40.0				

1. Displacement in accordance with ISO 1217 : 2009.

2. Noise level as per ISO 2151 and the basic standard ISO 9614-2, operation at maximum operating pressure and maximum speed; tolerance: ± 3 dB(A).

Notice: Specifications are subject to change without notice.





Low Pressure PM VSD Screw Air Compressor



Introduction

Jinjing low-pressure screw air compressor series is a new type of compressor born under the national policy of energy conservation, emission reduction and environmental protection proposed by the state. It has changed the traditional high-pressure compressor. The compressed air discharged from the compressor is depressurized and then transmitted to gas consuming equipment, resulting in a large waste of energy.

Air compressors with a pressure less than 0.5mpa are called low-pressure air compressors. We all know that the pressure of commonly used air compressors is generally 0.7mpa-0.8mpa, so many users buy air compressors even if the pressure is at They also bought a 0.7mpa air compressor for 0.3mpa, and then reduced the pressure through a pressure reducing valve for use at the gas end.

Because many users simply don't know that there are low pressure air compressors, low pressure air compressors. It is also a product designed by some air compressor manufacturers in response to customer pressure in recent years to better help enterprise users save energy.

Features

01

Output appropriate pressure, low energy consumption, high efficiency.

02

All the designs of the host meet the requirements of large flow and low pressure.

03

More than 30% energy saving than fix speed screw air compressor.

04

Increase the oil and gas separation equipment to ensure the oil content of export ≤ 2ppm.

05

Air source cleaning reduces the number of cleaning nozzles of texturing machine.

06

The heat dissipation area of the oil cooler should be increased by more than 30% to ensure normal operation in summer.

07

Independently design the internal voltage ratio of the host to ensure the optimal specific power.

08

Intelligent control system which automatically adjusts the displacement according to the customer's usage (inverter type).

09

The Internet of Things module can be selected to master the running status of the air compressor through the mobile terminal anytime and anywhere.

Why choose low pressure screw air compressor?

1.The exhaust volume remains the same, and the lower the pressure, the lower the motor power.

When the air pressure is 0.3--0.5Mpa, the use of a conventional 0.7Mpa air compressor will inevitably cause huge power waste. The use of a low-pressure air compressor can greatly increase the output of compressed air under the same motor power. In the end, You can save high-pressure and wasted electricity, generally 20-50% of electricity bills can be saved.

If you are a 0.7Mpa compressor, and the actual use pressure is 0.3Mpa, its working process is usually like this: the screw host first compresses the air to 0.7Mpa, and then reduces the pressure by 0.3Mpa through the pressure reducing valve. In other words, you are using a pressure of 0.3Mpa, and you are bearing a power consumption of 0.7Mpa.





## 2.The power remains the same, the lower the pressure, the greater the displacement.

A 132kW, 0.7Mpa screw air compressor, its displacement should generally be 24m<sup>3</sup>/min. And a 132kW, 0.5Mpa medium and low pressure screw air compressor, its displacement has generally reached 30.4 m<sup>3</sup>/min.

According to the user's pressure, the internal compression ratio is automatically adjusted, and the best specific power (energy efficiency) can be maintained within the exhaust pressure range of 0.3~0.5Mpa. The forced lubrication of the oil pump is adopted to ensure sufficient fuel injection and the best oil-gas mixing ratio under extremely low exhaust pressure.



### Water treatment industry:

sewage treatment, fermentation, bubble blowing.

## Application



### Glass industry:

The application of low-pressure screw air compressor in the glass industry is mainly used for bottle blowing and glassware.



### Cement industry:

The compressed air in the cement industry is mainly used for storage ventilation, cement slurry mixing, cement bag cleaning and sealing, dump trucks, and cleaning equipment.



### Cotton spinning:

looms, spindles, air-jet looms, air-coated yarn machines, texturing machines, etc.

## Parameter

### Low pressure single-stage compression PM VSD screw air compressor

Model	Pressure (mpa)	Displacement (m <sup>3</sup> /min)	Power (kw)	Dimension (mm)	Weight (kg)	Outlet Size
LPS-0.3/22	0.5	3.87	15	900x1150x1260	610	G 1 1/2"
LPS-0.3/22	0.3	7.16	22	1550*980*1360	840	G2"
LPS-0.5/22	0.5	6.3		900*1150*1260	690	
LPS-0.3/30	0.3	9.2	30	1680*1050*1395	890	G2"
LPS-0.5/30	0.5	8.22		1550*980*1360	840	
LPS-0.3/37	0.3	12.1	37	1800*1250*1600	1740	DN65
LPS-0.5/37	0.5	9.8		1680*1050*1395	890	
LPS-0.3/45	0.3	15	45	2020*1250*1650	1810	DN65
LPS-0.5/45	0.5	12		1800*1250*1600	1740	
LPS-0.3/55	0.3	19.3	55	2020*1250*1650	1920	DN80
LPS-0.5/55	0.5	15		2020*1250*1650	1810	
LPS-0.3/75	0.3	24.7	75	2500*1600*1800	3110	DN80
LPS-0.5/75	0.5	19.1		2020*1250*1650	1920	
LPS-0.3/90	0.3	28.8	90	2500*1600*1800	3230	DN100
LPS-0.5/90	0.5	21.5		2500*1600*1800	3110	
LPS-0.3/110	0.3	33	110	3100*1550*2200	3350	DN100
LPS-0.5/110	0.5	28.8		2500*1600*1800	3230	
LPS-0.3/132	0.3	45.5	132	3100*1550*2200	4350	DN125
LPS-0.5/132	0.5	34.7		2770*2050*2200	3570	
LPS-0.3/160	0.3	47	160	2900*1860*2000	4700	DN125
LPS-0.5/160	0.5	41.2		2770*2050*2200	4550	
LPS-0.3/185	0.3	50	185	2900*1860*2000	4770	DN125
LPS-0.5/185	0.5	47.4		2770*2050*2200	4550	
LPS-0.3/200	0.3	55.7	200	2900*1860*2000	4880	DN125
LPS-0.5/200	0.5	51.5		2770*2050*2200	4550	





Low pressure double-stage compression PM VSD screw air compressor

Model	Pressure (mpa)	Displacement (m <sup>3</sup> /min)	Power (kw)	Dimension (mm)	Weight (kg)	Outlet Size
2-LPS-0.5/18.5	0.5	4.14	18.5	1500*900*1220	960	G1 1/2"
2-LPS-0.5/22	0.5	5.32	22	1650*1120*1360	980	G1 1/2"
2-LPS-0.5/30	0.5	7.00	30	1650*1120*1360	1080	G1 1/2"
2-LPS-0.5/37	0.5	9.10	37	1800*1300*1600	1980	G 2"
2-LPS-0.3/45	0.3	15.30	45	2250x1410x1760	2280	G 2"
2-LPS-0.5/45	0.5	11.60		2150*1350*1640	2180	
2-LPS-0.3/55	0.3	18.90	55	2650x1654x1870	3200	G 2"
2-LPS-0.5/55	0.5	15.10		2250*1350*1760	2280	
2-LPS-0.3/75	0.3	24.00	75	2720x1800x1900	3360	DN65
2-LPS-0.5/75	0.5	19.00		2610*1810*2060	3200	
2-LPS-0.3/90	0.3	27.70	90	2750x1855x2200	3450	DN65
2-LPS-0.5/90	0.5	23.94		2600*1790*2050	3360	
2-LPS-0.3/110	0.3	32.60	110	3300x2060x2280	3850	DN80
2-LPS-0.5/110	0.5	27.45		2900*1890*2350	3450	
2-LPS-0.3/132	0.3	43.10	132	3300x2060x2280	3990	DN80
2-LPS-0.5/132	0.5	32.40		2900*1890*2350	3850	
2-LPS-0.3/160	0.3	50.70	160	3300x2060x2280	5890	DN80
2-LPS-0.5/160	0.5	41.20		3200*2100*2650	3990	
2-LPS-0.3/185	0.3	56.10	185	3300x2060x2280	6500	DN100
2-LPS-0.5/185	0.5	43.96		3200*2100*2650	5890	
2-LPS-0.3/200	0.3	60.10	200	4000x1780x1968	6800	DN125
2-LPS-0.5/200	0.5	50.46		3200*2100*2650	6500	
2-LPS-0.5/200	0.5	65.70		3350*2290*2750	6800	
2-LPS-0.5/200	0.5	73.40	280	4150*2200*2500	7200	DN125

1. Displacement in accordance with ISO 1217 : 2009.
2. Noise level as per ISO 2151 and the basic standard ISO 9614-2, operation at maximum operating pressure and maximum speed; tolerance: ± 3 dB(A).

Notice: Specifications are subject to change without notice.

Medium Pressure Screw Air Compressor



Introduction

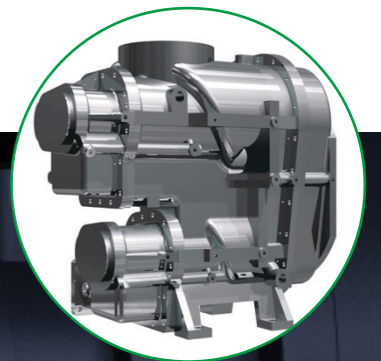

Two stage rotary screw air end

Discharge pressure up to 40 bar (= 580 psig).

Deliver 10-17% more air than a single-stage compressor without additional power.

Lower compression ratio per stage reduces bearing load and extends air terminal life.





Features

01

Beautiful appearance, compact structure and small floor area.

02

Large exhaust volume, stable pressure discharge and high efficiency.

03

Safe and reliable, stable operation, low noise, long maintenance cycle and service life.

04

The intelligent control system fully meets the needs of continuous operation without supervision.

05

Multiple medium pressure screw air compressor are online and automated, and automatically start and stop according to the gas consumption.

06

A single medium high pressure screw air compressor automatically adjusts the air supply according to the air consumption, which is more energy-saving.

Parameter

Model	Pressure (mpa)	Displacement (m <sup>3</sup> /min)	Power (kw)	Dimension (mm)	Outlet Size
MPS-3.0/75	3.0	6	75	2300*1550*1720	DN40
MPS-2.5/90	2.5	8	90	2500*1600*1850	DN40
MPS-2.5/132	2.5	12	132	2500*1700*1900	DN50
MPS-2.5/160	2.5	16	160	2680*1800*1950	DN50
MPS-2.5/185	2.5	20	185	2800*1850*2000	DN65
MPS-2.5/250	2.5	28	250	3100*2150*2300	DN65

1. Displacement in accordance with ISO 1217 : 2009.

2. Noise level as per ISO 2151 and the basic standard ISO 9614-2, operation at maximum operating pressure and maximum speed; tolerance: ± 3 dB(A).

Notice: Specifications are subject to change without notice.

Two Stage Compression Screw Air Compressor



Introduction

Natural air enters the stage compression through the air filter, mixes with a small amount of lubricating oil in the compression chamber, and compresses the mixed gas to the interstage pressure at the same time.

The compressed gas enters the cooling channel and comes into contact with a large amount of oil mist, thereby greatly reducing the temperature.

The cooled compressed gas enters the second-stage rotor, undergoes secondary compression, and is compressed to the final exhaust pressure.

Then discharge the compressor through the exhaust flange to complete the entire compression process.





## Structure

### Air End

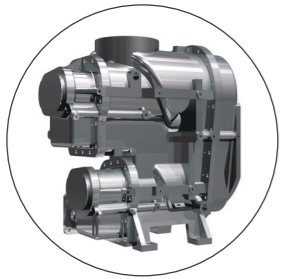

- The two-stage compression air end is used, that is, two groups of screw rotors with different sizes are used to realize reasonable pressure distribution.
- The internal leakage is reduced and the volumetric efficiency is improved.
- Reduce the load of the bearing and extend the life of the main engine.
- The main engine air intake adopts axial air intake to reduce air intake noise.

### Permanent magnet motor

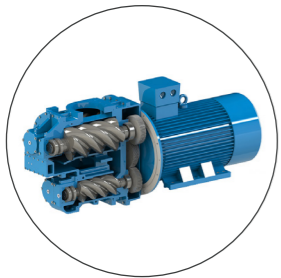

- Synchronous motor with permanent magnet and frequency converter without any bearing, elastic coupling or sealing washer.
- Eliminate wear, leakage and replacement.
- Conventional motors can be selected.

### Intelligent controller



- Increased reliability: durable keyboard, user-friendly, multilingual user interface.
- Improved ease of use: intuitive navigation system with main operation conditions include warning indications, maintenance scheduling etc.

### Centrifugal fan



- Low speed centrifugal fan specially used for oil cooler and air cooler. Separate fans maintain the optimum temperature of oil and air while producing extremely low noise levels.

### High quality accessories

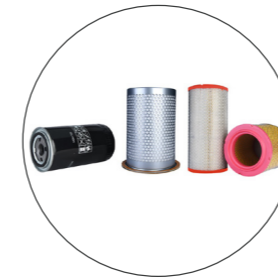

- Oil filter: excellent oil quality and purification capacity, ensures the cleanness and safety of the oil system. Long service life, easy replacement of filter element and low maintenance cost.
- Air filter: advanced air filter, with high efficiency of two-stage dust removal and filtration system, which can reach 99.9% even in heavy environment. Extend the service life of compressor elements and elements to ensure high air quality.

### Efficient separation system



- Reduce pressure drop and energy cost
- Low oil consumption to ensure minimum maintenance cost and long service life of compressor
- High quality air with low oil content: three-step oil-gas separation (centrifugal, gravity and filtration)

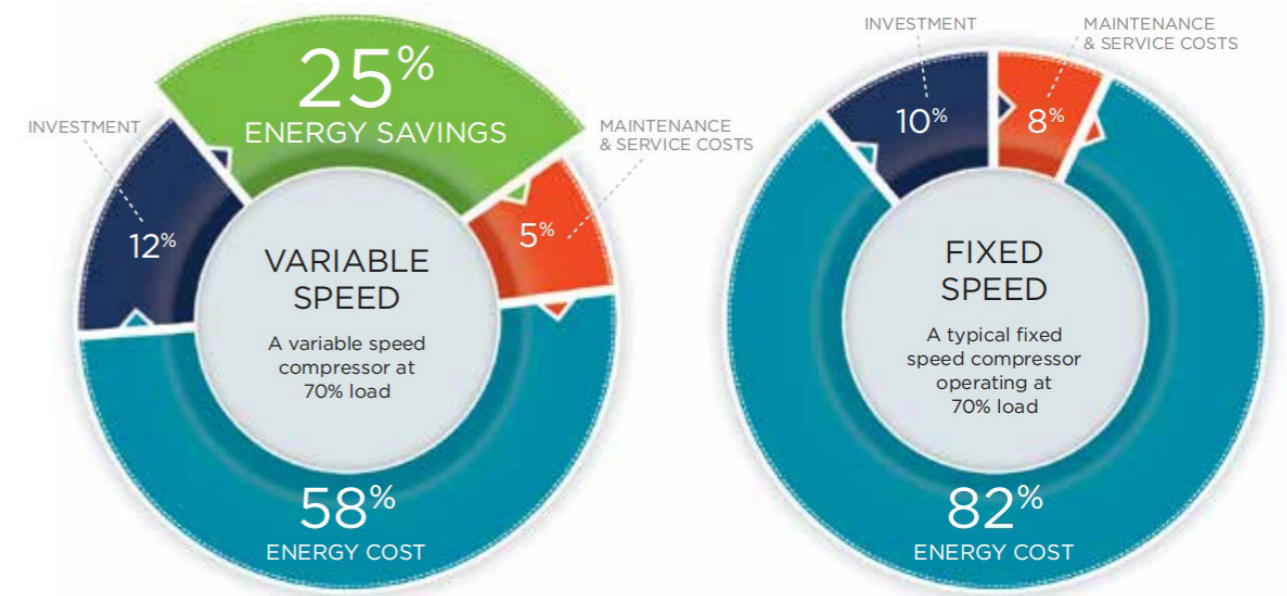





**ENERGY SAVINGS**  
with a Variable Speed Drive

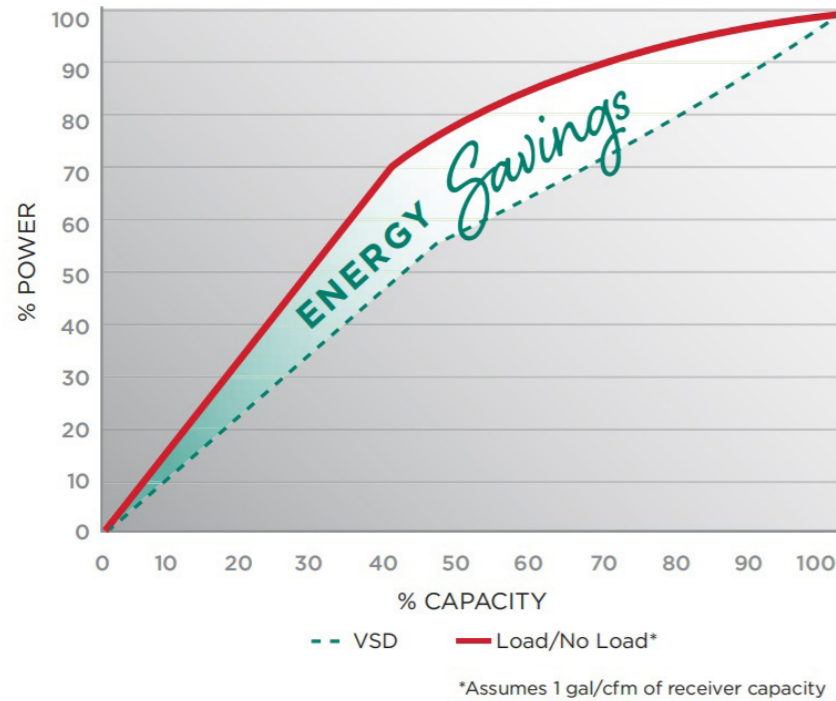

**Features**

**01**

High efficiency triple air separator to effectively maintain the internal cleanliness of the system.

**02**

High efficiency frequency conversion centrifugal fan is selected, with low noise, low vibration and high efficiency.

**03**

High precision glass fiber oil filter ensures that clean lubricating oil enters the main engine and prolongs the service life of the main engine.

**04**

Multiple safety protection: the controller has the functions of phase loss, imbalance, overload and high temperature protection for the main motor and fan.

**05**

Jinjing two-stage compression permanent magnet variable speed screw air compressor can achieve first-class energy efficiency.

**06**

The integrated bearingless high-efficiency permanent magnet motor has IP54 protection grade, less fault points and longer service life.

**Parameter**

**Two Stage Compression Fix Speed Screw Air Compressor**

Model	Pressure (mpa)	Displacement (m <sup>3</sup> /min)	Power (kw)	Dimension (mm)	Weight (kg)	Outlet Size
2FSS-0.7/15	0.7	2.8	15	1500*900*1220	660	Rp1"
2FSS-0.8/15	0.8	2.7				
2FSS-1.0/15	1.0	2.4				
2FSS-1.3/15	1.3	2.0	22	1500*900*1220	730	Rp1"
2FSS-0.7/22	0.7	4.2				
2FSS-0.8/22	0.8	4.1				
2FSS-1.0/22	1.0	3.5				
2FSS-1.3/22	1.3	3.2	30	1650*1090*1360	980	Rp1 1/2"
2FSS-0.7/30	0.7	6.4				
2FSS-0.8/30	0.8	6.3				
2FSS-1.0/30	1.0	4.9	37	1650*1090*1360	1080	Rp1 1/2"
2FSS-1.3/30	1.3	4.2				
2FSS-0.7/37	0.7	7.0				
2FSS-0.8/37	0.8	7.1	45	1800*1300*1600	1980	Rp2"
2FSS-1.0/37	1.0	5.8				
2FSS-1.3/37	1.3	5.4				
2FSS-0.7/45	0.7	9.8				
2FSS-0.8/45	0.8	9.7	55	2150*1350*1640	2180	Rp2"
2FSS-1.0/45	1.0	7.8				
2FSS-1.3/45	1.3	6.5				
2FSS-0.7/55	0.7	12.2				
2FSS-0.8/55	0.8	12.0	75	2250*1350*1760	2280	Rp2"
2FSS-1.0/55	1.0	9.6				
2FSS-1.3/55	1.3	8.6				
2FSS-0.7/75	0.7	16.8				
2FSS-0.8/75	0.8	16.5	90	2600*1790*2050	2650	Rp2"
2FSS-1.0/75	1.0	12.5				
2FSS-1.3/75	1.3	11.2				
2FSS-0.7/90	0.7	19.8				
2FSS-0.8/90	0.8	19.2	90	2600*1790*2050	2650	Rp2"
2FSS-1.0/90	1.0	16.9				
2FSS-1.3/90	1.3	14.3				





Model	Pressure (mpa)	Displacement (m³/min)	Power (kw)	Dimension (mm)	Weight (kg)	Outlet Size
2FSS-0.7/110	0.7	23.6	110	2600*1790*2050	3000	Rp2"
2FSS-0.8/110	0.8	23.1				
2FSS-1.0/110	1.0	19.7				
2FSS-1.3/110	1.3	17.6				
2FSS-0.7/132	0.7	30.0	132	2900*1890*2350	3450	DN80
2FSS-0.8/132	0.8	28.0				
2FSS-1.0/132	1.0	23.5				
2FSS-1.3/132	1.3	19.8				
2FSS-0.7/160	0.7	34.5	160	2900*1890*2350	3850	DN80
2FSS-0.8/160	0.8	33.6				
2FSS-1.0/160	1.0	30.0				
2FSS-1.3/160	1.3	28.3				
2FSS-0.7/185	0.7	41.0	185	3200*2100*2650	3990	DN100
2FSS-0.8/185	0.8	38.4				
2FSS-1.0/185	1.0	32.5				
2FSS-1.3/185	1.3	28.6				
2FSS-0.7/200	0.7	44.6	200	3200*2100*2650	5890	DN100
2FSS-0.8/200	0.8	43.0				
2FSS-1.0/200	1.0	38.5				
2FSS-1.3/200	1.3	32.8				
2FSS-0.7/220	0.7	48.6	220	3200*2100*2650	6500	DN100
2FSS-0.8/220	0.8	47.0				
2FSS-1.0/220	1.0	41.9				
2FSS-1.3/220	1.3	38.0				
2FSS-0.7/250	0.7	55.0	250	3350*2290*2750	6800	DN125
2FSS-0.8/250	0.8	54.0				
2FSS-1.0/250	1.0	46.0				
2FSS-1.3/250	1.3	40.0				
2FSS-0.7/280	0.7	62.0	280	3350*2290*2750	7200	DN125
2FSS-0.8/280	0.8	60.0				
2FSS-1.0/280	1.0	51.0				
2FSS-1.3/280	1.3	45.0				
2FSS-0.7/315	0.7	69.0	315	4150*2200*2500	7800	DN125
2FSS-0.8/315	0.8	67.5				
2FSS-1.0/315	1.0	61.0				
2FSS-1.3/315	1.3	51.0				
2FSS-0.7/280W	0.7	62.0	280	3350*2290*2750 (Water coling)	7200	DN125
2FSS-0.8/280W	0.8	60.0				
2FSS-1.0/280W	1.0	51.0				
2FSS-1.3/280W	1.3	45.0				
2FSS-0.7/315W	0.7	69.0	315	4150*2200*2500 (Water coling)	7800	DN125
2FSS-0.8/315W	0.8	67.5				
2FSS-1.0/315W	1.0	61.0				
2FSS-1.3/315W	1.3	51.0				

**Two Stage Compression Permanent Magnet Variable Speed Screw Air Compressor**

Model	Pressure (mpa)	Displacement (m³/min)	Power (kw)	Dimension (mm)	Weight (kg)	Outlet Size
2PV-0.7/15	0.7	2.8	15	1500*900*1220	660	Rp1"
2PV-0.8/15	0.8	2.7				
2PV-1.0/15	1.0	2.4				
2PV-1.3/15	1.3	2.0	22	1500*900*1220	730	Rp1"
2PV-0.7/22	0.7	4.2				
2PV-0.8/22	0.8	4.1				
2PV-1.0/22	1.0	3.5	30	1650*1090*1360	980	Rp1 1/2"
2PV-1.3/22	1.3	3.2				
2PV-0.7/30	0.7	6.4				
2PV-0.8/30	0.8	6.3	37	1650*1090*1360	1080	Rp1 1/2"
2PV-1.0/30	1.0	4.9				
2PV-1.3/30	1.3	4.2				
2PV-0.7/37	0.7	7.0	45	1800*1300*1600	1980	Rp2"
2PV-0.8/37	0.8	7.1				
2PV-1.0/37	1.0	5.8				
2PV-1.3/37	1.3	5.4	55	2150*1350*1640	2180	Rp2"
2PV-0.7/45	0.7	9.8				
2PV-0.8/45	0.8	9.7				
2PV-1.0/45	1.0	7.8	75	2250*1350*1760	2280	Rp2"
2PV-1.3/45	1.3	6.5				
2PV-0.7/55	0.7	12.2				
2PV-0.8/55	0.8	12.0	90	2600*1790*2050	2650	Rp2"
2PV-1.0/55	1.0	9.6				
2PV-1.3/55	1.3	8.6				
2PV-0.7/75	0.7	16.8	110	2600*1790*2050	3000	Rp2"
2PV-0.8/75	0.8	16.5				
2PV-1.0/75	1.0	12.5				
2PV-1.3/75	1.3	11.2	132	2900*1890*2350	3450	DN80
2PV-0.7/90	0.7	19.8				
2PV-0.8/90	0.8	19.2				
2PV-1.0/90	1.0	16.9	132	2900*1890*2350	3450	DN80
2PV-1.3/90	1.3	14.3				
2PV-0.7/110	0.7	23.6				
2PV-0.8/110	0.8	23.1	132	2900*1890*2350	3450	DN80
2PV-1.0/110	1.0	19.7				
2PV-1.3/110	1.3	17.6				
2PV-0.7/132	0.7	30.0	132	2900*1890*2350	3450	DN80
2PV-0.8/132	0.8	28.0				
2PV-1.0/132	1.0	23.5				
2PV-1.3/132	1.3	19.8	132	2900*1890*2350	3450	DN80





8bar/0.8mpa/116psi

**Four in One Integrated Screw Air Compressor**



**Introduction**

Combined (integrated) screw air compressor integrates screw compressor, refrigeration dryer, precision filter, air storage tank and other elements.

After the air is integrated into the system, the air quality is obviously optimized, which can meet the process needs of various enterprises, improve the production efficiency and save the production cost for users to the greatest extent.

Model	Pressure (mpa)	Displacement (m³/min)	Power (kw)	Dimension (mm)	Weight (kg)	Outlet Size
2PV-0.7/160	0.7	34.5	160	2900*1890*2350	3850	DN80
2PV-0.8/160	0.8	33.6				
2PV-1.0/160	1.0	30.0				
2PV-1.3/160	1.3	28.3				
2PV-0.7/185	0.7	41.0	185	3200*2100*2650	3990	DN100
2PV-0.8/185	0.8	38.4				
2PV-1.0/185	1.0	32.5				
2PV-1.3/185	1.3	28.6				
2PV-0.7/200	0.7	44.6	200	3200*2100*2650	5890	DN100
2PV-0.8/200	0.8	43.0				
2PV-1.0/200	1.0	38.5				
2PV-1.3/200	1.3	32.8				
2PV-0.7/220	0.7	48.6	220	3200*2100*2650	6500	DN100
2PV-0.8/220	0.8	47.0				
2PV-1.0/220	1.0	41.9				
2PV-1.3/220	1.3	38.0				
2PV-0.7/250	0.7	55.0	250	3350*2290*2750	6800	DN125
2PV-0.8/250	0.8	54.0				
2PV-1.0/250	1.0	46.0				
2PV-1.3/250	1.3	40.0				
2PV-0.7/280	0.7	62.0	280	3350*2290*2750	7200	DN125
2PV-0.8/280	0.8	60.0				
2PV-1.0/280	1.0	51.0				
2PV-1.3/280	1.3	45.0				
2PV-0.7/315	0.7	69.0	315	4150*2200*2500	7800	DN125
2PV-0.8/315	0.8	67.5				
2PV-1.0/315	1.0	61.0				
2PV-1.3/315	1.3	51.0				
2PV-0.7/280W	0.7	62.0	280	3350*2290*2750 (Water cooling)	7200	DN125
2PV-0.8/280W	0.8	60.0				
2PV-1.0/280W	1.0	51.0				
2PV-1.3/280W	1.3	45.0				
2PV-0.7/315W	0.7	69.0	315	4150*2200*2500 (Water cooling)	7800	DN125
2PV-0.8/315W	0.8	67.5				
2PV-1.0/315W	1.0	61.0				
2PV-1.3/315W	1.3	51.0				

1. Displacement in accordance with ISO 1217 : 2009.

2. Noise level as per ISO 2151 and the basic standard ISO 9614-2, operation at maximum operating pressure and maximum speed; tolerance: ± 3 dB(A).

Notice: Specifications are subject to change without notice.





### Features

01

Integrated design, greatly saving customers' installation cost and use space, and beautiful appearance.

02

New modular structure design, compact layout; Ready to use, easy to move.

03

The unit has been strictly tested, and the vibration value of the unit is far lower than the national standard value.

04

Directly discharge dry compressed air to fully ensure the gas quality of user terminal.

05

Multiple linkage controls can be set according to customer requirements.

06

Aluminum plate fin cooler has compact structure, light weight, and high heat transfer efficiency, so that the unit can be used in high temperature environment.

### Parameter

Model	Pressure (mpa)	Displacement (m <sup>3</sup> /min)	Power (kw)	Tank&Pressure	Dimension (mm)	Weight (kg)
4-1S-0.8/7.5	0.8	0.33-1.1	7.5	300L/1.25mpa	1760*650*1570	580
4-1S-0.8/11		0.48-1.6	11	360L/1.25mpa	2020*750**1690	650
4-1S-0.8/15		0.66-2.2	15	360L/1.25mpa	2020*750**1690	680
4-1S-0.8/22		1.05-3.5	22	500L/1.25mpa	2170*950*1900	750

1. Displacement in accordance with ISO 1217 : 2009.

2. Noise level as per ISO 2151 and the basic standard ISO 9614-2, operation at maximum operating pressure and maximum speed; tolerance: ± 3 dB(A).

Notice: Specifications are subject to change without notice.

16bar/1.6mpa/232psi

### Screw Air Compressor for Laser Cutting



### Introduction

Jinjing Screw air compressor for laser cutting is suitable for 500-10000W laser cutting machine, constant pressure 1.6MPa, built-in high-quality cold dryer + 4 high-precision filters + 500L air tank to ensure that the compressed air has no liquid water, no steam, no refraction.

Professional integrated design, small footprint, easy installation, plug and play, constant voltage, easy maintenance, it is a good gold partner for laser cutting machines!



## Features

01

High-performance refrigerated dryer with imported precision filter, output high-quality compressed air.

02

Highly integrated, modular structure design, compact and beautiful, convenient maintenance.

03

The main oil pipe is connected by flexible pipes, which effectively reduces vibration and noise.

04

Integrated and optimized pipeline design reduces the incidence of pipeline leakage.

05

Directly discharge dry compressed air to fully ensure the gas quality of user terminal.

06

Aluminum plate fin cooler has compact structure, light weight and high heat transfer efficiency.

## Structure



### High quality air end

- The original high-quality motor adopts large rotor low speed design and contains two independent compression units, with high efficiency and low noise, which not only ensures high efficiency, but also ensures high stability and smoother cutting.

### Intelligent monitoring



- Multi-function touch button dual-purpose screen, double guarantee, support Chinese and English menus, and select other national languages. It is simple to operate and the system can be monitored in real time.



### Frequency conversion distribution box

- Imported electronic elements with high protection and safety level ensure the stable operation of the equipment, and the electrical part is enlarged by 30 ~ 50%.



### Freezing dryer

- Pressure dew point 2-10°C , high pressure design, water removal effect, efficient filtration, automatic and manual double blowdown design to remove residual substances. Increase the heat dissipation mesh.



### High precision filter

- The rotary oil filter with high-precision filter paper is adopted to completely filter the impurities in the lubricating oil, ensure the cleanness of the lubricating oil and prolong the service life of the compressor air end. And it can protect the lens and cutter air end of the laser cutting machine.

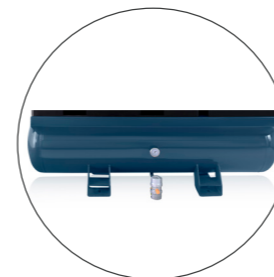

### Large capacity air storage tank

- Super large capacity, more energy and power saving, thickened material, cushioning, cooling, water removal and stable air pressure ( Optional casters for easy movement).

## Parameter

Model	Pressure (mpa)	Displacement (m³/min)	Power (kw)	Tank&Pressure	Dimension (mm)	Weight (kg)
LCS-1.6/11	1.6	1.1	11	360L/1.6mpa	2020*750*1850	680
LCS-1.6/15		1.75	15	360L/1.6mpa	2020*750*1850	700
LCS-1.6/22		2.25	22	500L/1.6mpa	2170*950*2000	780
LCS-1.6/37		2.65	37	500L/1.6mpa	2500*2000*1800	850





## Oil Cooled PM VSD Air Compressor



### Structure

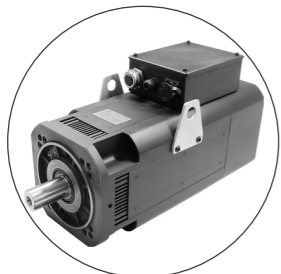

#### Oil cooled integrated permanent magnet motor

- super efficient oil cooled permanent magnet motor, SAP's unique leak proof design, eliminate the risk of leakage.
- It has excellent cooling effect.



#### Low speed centrifugal fan

- Low speed centrifugal fan specially used for oil cooler and air cooler.
- Separate fans maintain the optimum temperature of oil and air while producing extremely low noise levels.



#### Air / oil cooler

- Easy to place and clean.



#### Freezing dryer/Oil gas separation tank

- The unique cyclone technology ensures the pre separation efficiency of more than 99.9%.
- The separator ensures a low oil entrainment of less than 2 ppm, thereby reducing maintenance.

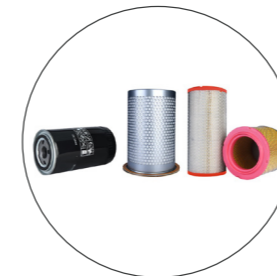

#### Air inlet filter

- Remove the smallest dust and dirt particles. Large surface area ensures long life and minimum pressure loss.
- Located near the removable panel for easy access.

### Advantages

#### Integrated shaft design, more power transmission

- ① The permanent magnet motor and the compression main engine adopt the built-in integrated shaft direct connection structure, and the transmission efficiency is 100%.
- ② IP65 protection grade, waterproof and dustproof.
- ③ The motor bearings do not need to be greased and maintenance-free.
- ④ Using one-piece non-cantilever shaft design and long-life oil seal design.

#### Computer intelligent controller

By collecting big data, you can view the real-time data of your compressed air system on any computer and mobile phone only through the Internet browser, and truly realize unattended operation.



### Remote IOT detection system

Carry out life cycle management, remote detection, remote management, mobile phone early warning, data acquisition, etc. of air compressor equipment through Internet of things technology.

### Equipped with filter and thermostatic control valve

The high-efficiency heavy-duty air inlet filter is adopted to ensure the air inlet quality of the compressor, ensure the safety of the main engine and greatly improve the service life of the equipment. With thermostatic control valve, the temperature of cooling lubricating oil is automatically controlled, so that the machine can be easily controlled in the normal working range.

### Mute design

Special air duct design reduces wind resistance and noise by 20%. Sound insulation baffles are carefully selected sound insulation cotton to strive for noise reduction in details.

### Customized frequency converter

The high-end algorithm of junction temperature estimation is adopted, and the temperature rise of the inverter module is greatly used to improve the overload capacity. The use of energy-saving control algorithms reduces the running current of the motor and maximizes the efficiency of the motor.



### Parameter

Model	Pressure (mpa)	Displacement (m³/min)	Power (kw)	Dimension (mm)	Weight (kg)	Outlet Size
OCPV-0.7/7.5	0.7	1.20	7.5	840*620*850	400	G3/4"
OCPV-0.8/7.5	0.8	1.10				
OCPV-1.0/7.5	1.0	0.95				
OCPV-1.3/7.5	1.3	0.80				
OCPV-0.7/11	0.7	1.70	11	1150*750*1020	450	G1"
OCPV-0.8/11	0.8	1.60				
OCPV-1.0/11	1.0	1.40				
OCPV-1.3/11	1.3	1.20				
OCPV-0.7/15	0.7	2.40	15	1150*750*1020	500	G1"
OCPV-0.8/15	0.8	2.20				
OCPV-1.0/15	1.0	2.00				
OCPV-1.3/15	1.3	1.70				
OCPV-0.7/22	0.7	3.80	22	1300*850*1140	600	Rp1 1/4"
OCPV-0.8/22	0.8	3.50				
OCPV-1.0/22	1.0	3.20				
OCPV-1.3/22	1.3	2.90				
OCPV-0.7/37	0.7	6.40	37	1500*950*1230	800	Rp1 1/2"
OCPV-0.8/37	0.8	6.10				
OCPV-1.0/37	1.0	5.70				
OCPV-1.3/37	1.3	5.00				
OCPV-0.7/45	0.7	8.00	45	1500*950*1230	850	Rp1 1/2"
OCPV-0.8/45	0.8	7.70				
OCPV-1.0/45	1.0	7.00				
OCPV-1.3/45	1.3	5.80				
OCPV-0.7/55	0.7	10.50	55	1500*1100*1450	900	DN50
OCPV-0.8/55	0.8	9.80				
OCPV-1.0/55	1.0	8.70				
OCPV-1.3/55	1.3	7.60				
OCPV-0.7/75	0.7	13.60	75	1500*1100*1450	950	DN50
OCPV-0.8/75	0.8	13.30				
OCPV-1.0/75	1.0	11.60				
OCPV-1.3/75	1.3	9.80				

1. Displacement in accordance with ISO 1217 : 2009.

2. Noise level as per ISO 2151 and the basic standard ISO 9614-2, operation at maximum operating pressure and maximum speed; tolerance: ± 3 dB(A).

Notice: Specifications are subject to change without notice.





# Water Lubricated Oil-free Screw Air Compressor



Structure

Oil-free Screw Air Compressor



## Water filter

- The shell is made of stainless steel, and the special filter element has high filtering precision and long service life, to ensure that the system is clean and free of impurities.



## Air end

- All stainless-steel air end, using the world's advanced sealing system, integrating mechanical seal, air curtain chamber, labyrinth seal and bypass channel.

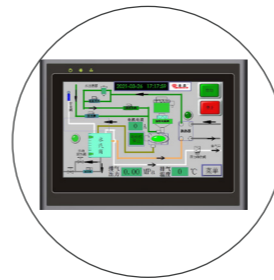

## Human machine interface system

- The most humanized design, using advanced automatic control technology, simple operation, with fault diagnosis and reminder function.



## Solenoid valve

- Select international famous brand and all stainless steel for water quality conditions. Compact structure, sensitive action, zero pressure start and waterproof.



## Air filter

- with pre filtration function and folding filter element, it has less pressure loss and is durable.



## Water level controller

- accurately monitor the water level of the system and automatically realize the water supply, waterproof and water change of the system.



**Parameter**

**Oil-free Water Lubricated Fix Speed Screw Air Compressor**

Model	Pressure (mpa)	Displacement (m <sup>3</sup> /min)	Power (kw)	Cooling Water Outlet/Inlet Diameter	Quantity of Cooling Water		Quantity of Lubricating Water (L)	Dimension (mm)	Weight (kg)	Outlet Size
					Inlet Water 32°C T/H					
WLS0.8-5.5FS	0.8	0.72	5.5	3/4"	1.5		10	800*800*1200	300	3/4"
WLS1.0-5.5FS	1.0	0.65								
WLS0.8-7.5FS	0.8	1.05	7.5	3/4"	2		10	800*800*1200	300	3/4"
WLS1.0-7.5FS	1.0	0.8								
WLS0.8-11FS	0.8	1.72	11	1"	2.5		26	1200*755*1130	420	3/4"
WLS1.0-11FS	1.0	1.42								
WLS0.8-15FS	0.8	2.25	15	1"	3.5		26	1200*755*1130	420	3/4"
WLS1.0-15FS	1.0	1.92								
WLS0.8-18.5FS	0.8	3	18.5	1"	4		30	1400*900*1270	600	1"
WLS1.0-18.5FS	1.0	2.2								
WLS0.8-22FS	0.8	3.65	22	1"	5		30	1400*900*1270	620	1"
WLS1.0-22FS	1.0	3								
WLS0.8-30FS	0.8	5	30	1 1/2"	7		40	1400*950*1380	740	1 1/4"
WLS1.0-30FS	1.0	3.9								
WLS0.8-37FS	0.8	6.3	37	1 1/2"	9		40	1580*1000*1475	860	1 1/4"
WLS1.0-37FS	1.0	5.33								
WLS0.8-45FS	0.8	7.8	45	1 1/2"	10		90	2050*1360*1688	1020	2"
WLS1.0-45FS	1.0	6.3								
WLS0.8-55FS	0.8	10.1	55	1 1/2"	12		100	2050*1360*1688	1080	2"
WLS1.0-55FS	1.0	7.9								

**Oil-free Water Lubricated PM VSD Screw Air Compressor**

Model	Pressure (mpa)	Displacement (m <sup>3</sup> /min)	Power (kw)	Cooling Water Outlet/Inlet Diameter	Quantity of Cooling Water		Quantity of Lubricating Water (L)	Dimension (mm)	Weight (kg)	Outlet Size
					Inlet Water 32°C T/H					
WLS0.8-5.5PV	0.8	0.3~0.78	5.5	3/4"	1.5		10	800*800*1200	320	3/4"
WLS1.0-5.5PV	1.0	0.2~0.65								
WLS0.8-7.5PV	0.8	0.35~1.17	7.5	3/4"	2		10	800*800*1200	320	3/4"
WLS1.0-7.5PV	1.0	0.3~1.05								
WLS0.8-11PV	0.8	0.54~1.72	11	1"	2.5		26	1200*755*1130	400	3/4"
WLS1.0-11PV	1.0	0.45~1.42								
WLS0.8-15PV	0.8	0.75~2.43	15	1"	3.5		26	1200*755*1130	440	3/4"
WLS1.0-15PV	1.0	0.65~2.17								
WLS0.8-18.5PV	0.8	0.9~3.13	18.5	1"	4		30	1400*900*1270	640	1"
WLS1.0-18.5PV	1.0	0.9~2.82								
WLS0.8-22PV	0.8	1.1~3.7	22	1"	5		30	1400*900*1270	640	1"
WLS1.0-22PV	1.0	0.97~3.21								
WLS0.8-30PV	0.8	1.55~5.2	30	1 1/4"	7		40	1400*950*1380	760	1 1/4"
WLS1.0-30PV	1.0	1.25~4.43								
WLS0.8-37PV	0.8	1.91~6.5	37	1 1/4"	9		40	1580*1000*1475	880	1 1/4"
WLS1.0-37PV	1.0	1.6~5.33								
WLS0.8-45PV	0.8	2.5~8.3	45	2"	10		90	2050*1360*1688	1050	2"
WLS1.0-45PV	1.0	1.91~6.3								
WLS0.8-55PV	0.8	3.0~10.3	55	2"	12		100	2050*1360*1688	1100	2"
WLS1.0-55PV	1.0	2.6~8.55								
WLS0.8-75PV	0.8	3.95~13.0	75	2"	18		100	1800*1360*1670	1230	2"
WLS1.0-75PV	1.0	3.4~11.5								
WLS0.8-90PV	0.8	5.0~16.6	90	2"	20		120	2200*1550*1800	2080	2 1/2"
WLS1.0-90PV	1.0	4.3~14.6								
WLS0.8-110PV	0.8	6.0~20.2	110	2"	24		120	2200*1550*1800	2230	2 1/2"
WLS1.0-110PV	1.0	5.0~16.6								
WLS0.8-132PV	0.8	6.75~23.5	132	2"	30		120	2200*1550*1800	2360	2 1/2"
WLS1.0-132PV	1.0	6.0~19.9								
WLS0.8-160PV	0.8	8.5~28.1	160	3"	35		160	2700*1830*1850	3900	DN80
WLS1.0-160PV	1.0	7.6~25.4								
WLS0.8-185PV	0.8	10.0~31.3	185	3"	38		160	2700*1830*1850	4050	DN80
WLS1.0-185PV	1.0	8.7~29.0								
WLS0.8-200PV	0.8	11.2~36.7	200	4"	42		200	2700*1830*1850	4200	DN100
WLS1.0-200PV	1.0	9.6~31.8								
WLS0.8-220PV	0.8	12.2~39.6	220	4"	47		200	2700*1830*1850	4400	DN100
WLS1.0-220PV	1.0	11.2~35.7								
WLS0.8-250PV	0.8	13.5~45.0	250	4"	53		200	2700*1830*1850	4800	DN100
WLS1.0-250PV	1.0	12.3~40.0								

Oil-free Screw Air Compressor





**Oil-free Water Lubricated Low Pressure Screw Air Compressor**

Model	Pressure (mpa)	Displacement (m <sup>3</sup> /min)	Power (kw)	Cooling Water Outlet/Inlet Diameter	Quantity of Cooling Water		Quantity of Lubricating Water (L)	Dimension (mm)	Weight (kg)	Outlet Size
					Inlet Water 32°C	T/H				
WLS0.4-30LP	0.4	6.7	30	1 1/2"	7	50	1650*1180*1505	1200	2"	
WLS0.4-37LP	0.4	8.6	37	1 1/2"	9	60	1650*1180*1505	1300	2 1/2"	
WLS0.4-45LP	0.4	10.5	45	1 1/2"	10	120	1800*1360*1670	1500	2 1/2"	
WLS0.4-55LP	0.4	13.5	55	1 1/2"	12	160	1800*1360*1670	1670	2 1/2"	
WLS0.4-75LP	0.4	19.9	75	1 1/2"	18	160	1800*1360*1670	1300	3"	
WLS0.4-90LP	0.4	23	90	1 1/2"	20	180	2200*1550*1800	2550	3"	
WLS0.4-110LP	0.4	28.2	110	2"	24	180	2200*1550*1800	2600	4"	
WLS0.4-132LP	0.4	30	132	2"	30	180	2200*1550*1800	2800	4"	
WLS0.4-160LP	0.4	36	160	3"	35	230	3000*1800*2100	4000	5"	
WLS0.4-185LP	0.4	42	185	3"	38	230	3000*1800*2100	4350	5"	

**Oil-free Water Lubricated Middle Pressure Screw Air Compressor**

Model	Pressure (mpa)	Displacement (m <sup>3</sup> /min)	Power (kw)	Cooling Water Outlet/Inlet Diameter	Quantity of Cooling Water		Quantity of Lubricating Water (L)	Dimension (mm)	Weight (kg)	Outlet Size
					Inlet Water 32°C	T/H				
WLS4-37MP	4	3.5	37	1"	10	80	1800*1360*1710	1200	1"	
WLS4-65MP	4	6	65	1 1/2"	18	120	1800*1360*1710	1800	1"	
WLS4-110MP	4	10	110	2"	28	160	3000*1560*1680	2260	1 1/2"	
WLS4-132MP	4	12	132	2"	35	170	3000*1800*2100	2500	1 1/2"	
WLS4-165MP	4	15	165	2 1/2"	40	190	3000*1800*2100	2980	2"	
WLS4-220MP	4	20	220	3"	50	200	3000*2100*2200	3200	2"	
WLS4-275MP	4	25	275	3"	56	250	3000*2100*2200	4600	2 1/2"	
WLS4-460MP	4	42	460	4"	95	360	4200*3600*2200	5800	3"	

**Principle**

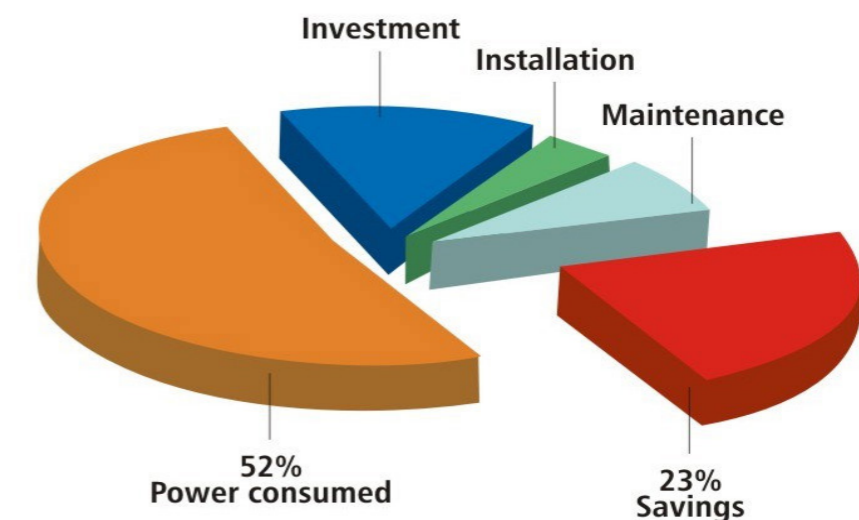
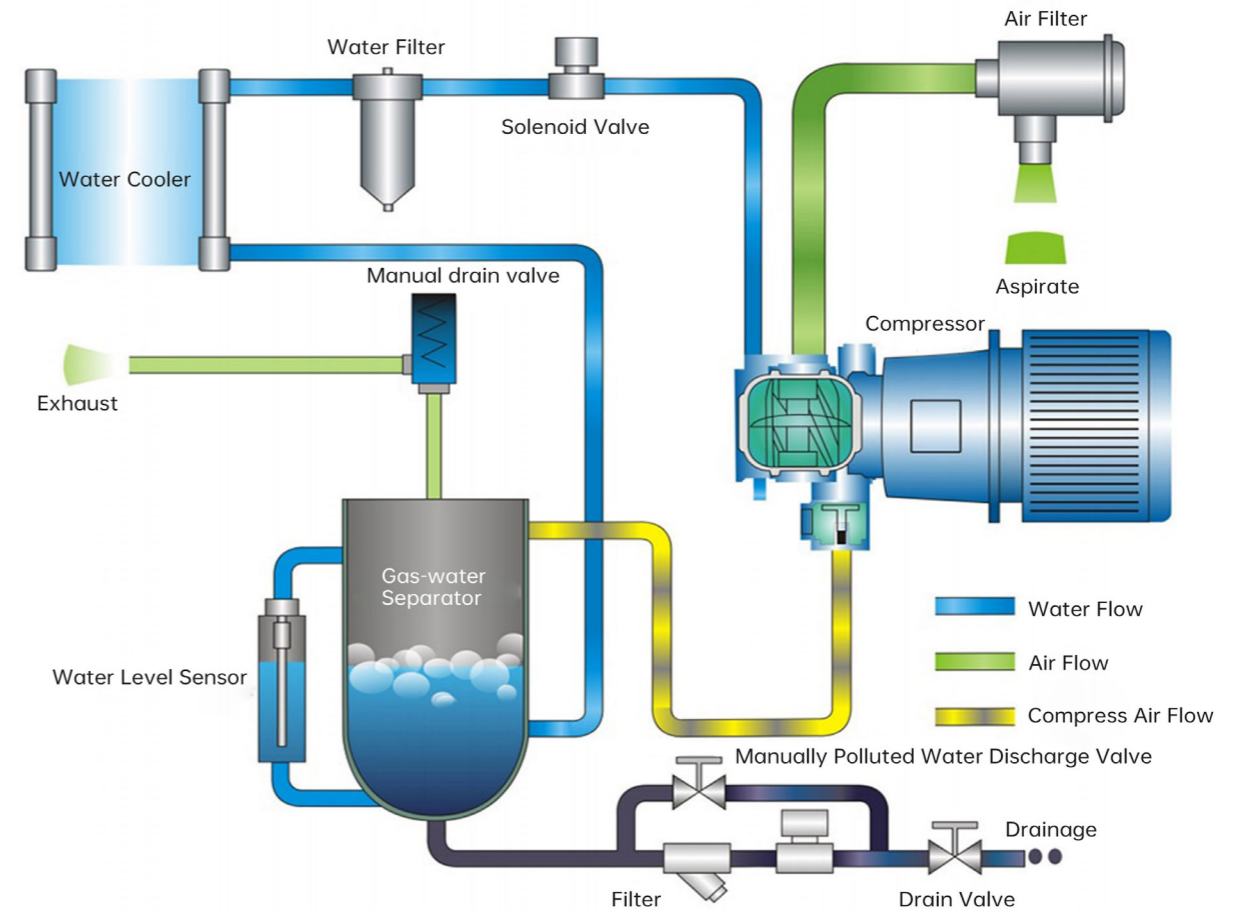



**Dry Oil-free Screw Air Compressor**

**Parameter**



Oil-free Screw Air Compressor

**Features**

**01**

IE3 motor, class B temperature rise, suitable for harsh environments such as large dust and high temperature.

**02**

Multiple noise reduction design, with special flame retardant silencing cotton inside to reduce the noise of the unit.

**03**

Independent air inlet to reduce air inlet resistance. Multifunctional intake valve group, no-load start.

**04**

Centrifugal fan with plate fin cooler has the characteristics of high wind pressure and low noise.

**05**

The cooler is of modular design and vertical installation, reducing thermal stress, stable operation, and long service life.

**06**

Optimize the damping pad to reduce vibration and noise.

Model	Pressure (mpa)	Displacement (m <sup>3</sup> /min)	Power (kw)	Dimension (mm)	Weight (kg)	Outlet Size
DTS-0.75/55	0.75	9.2	55	2700*1500*1970	2600	G-1/2"
DTS-0.85/55	0.85	9.1				
DTS-1.05/55	1.05	8.0				
DTS-0.75/75	0.75	12.5	75	2700*1500*1970	2800	DN50
DTS-0.85/75	0.85	11.6				
DTS-1.05/75	1.05	10.8				
DTS-0.75/90	0.75	13.4	90	2700*1500*1970	3400	DN50
DTS-0.85/90	0.85	13.4				
DTS-1.05/90	1.05	12.4				
DTS-0.75/110	0.75	20.0	110	2800*1800*1860	3400	DN65
DTS-0.85/110	0.85	18.7				
DTS-1.05/110	1.05	16.5				
DTS-0.75/132	0.75	23.6	132	2800*1800*1860	3450	DN65
DTS-0.85/132	0.85	22.1				
DTS-1.05/132	1.05	20.0				
DTS-0.75/160	0.75	26.8	160	2800*1800*1860	3550	DN65
DTS-0.85/160	0.85	25.5				
DTS-1.05/160	1.05	23.5				
DTS-0.75/185	0.75	29.7	185	2800*1800*1860	3950	DN65
DTS-0.85/185	0.85	29.6				
DTS-1.05/185	1.05	26.8				
DTS-0.75/200	0.75	35.5	200	3100*2150*2200	4500	DN100
DTS-0.85/200	0.85	33.3				
DTS-1.05/200	1.05	29.9				
DTS-0.75/220	0.75	36.0	220	3100*2150*2200	5000	DN100
DTS-0.85/220	0.85	35.9				
DTS-1.05/220	1.05	33.3				
DTS-0.75/250	0.75	42.8	250	3100*2150*2200	5200	DN100
DTS-0.85/250	0.85	42.7				
DTS-1.05/250	1.05	38.3				
DTS-0.75/280	0.75	46.7	280	3400*2400*2200	6400	DN100
DTS-0.85/280	0.85	45.6				
DTS-1.05/280	1.05	42.6				
DTS-0.75/315	0.75	51.4	315	3400*2400*2200	6400	DN125
DTS-0.85/315	0.85	51.2				
DTS-1.05/315	1.05	46.5				
DTS-0.75/355	0.75	58.4	355	3400*2400*2200	6400	DN125
DTS-0.85/355	0.85	57.9				
DTS-1.05/355	1.05	51.0				





Maglev Blower



Introduction

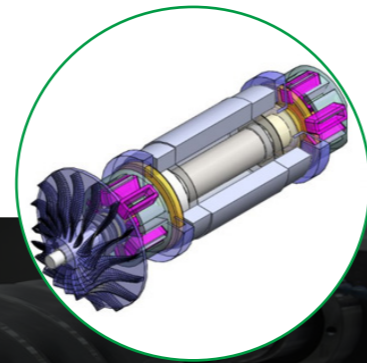

Magnetic levitation blower is a kind of turbine with magnetic levitation bearing.

The main structure is that the blower impeller is directly installed on the extended end of the motor shaft, and the rotor is vertically suspended on the active magnetic bearing controller. It does not need speed increaser and coupling to realize direct drive by high-speed motor.

The core of the single-stage high-speed centrifugal blower regulated by frequency converter is the technology of magnetic bearing and permanent magnet motor.

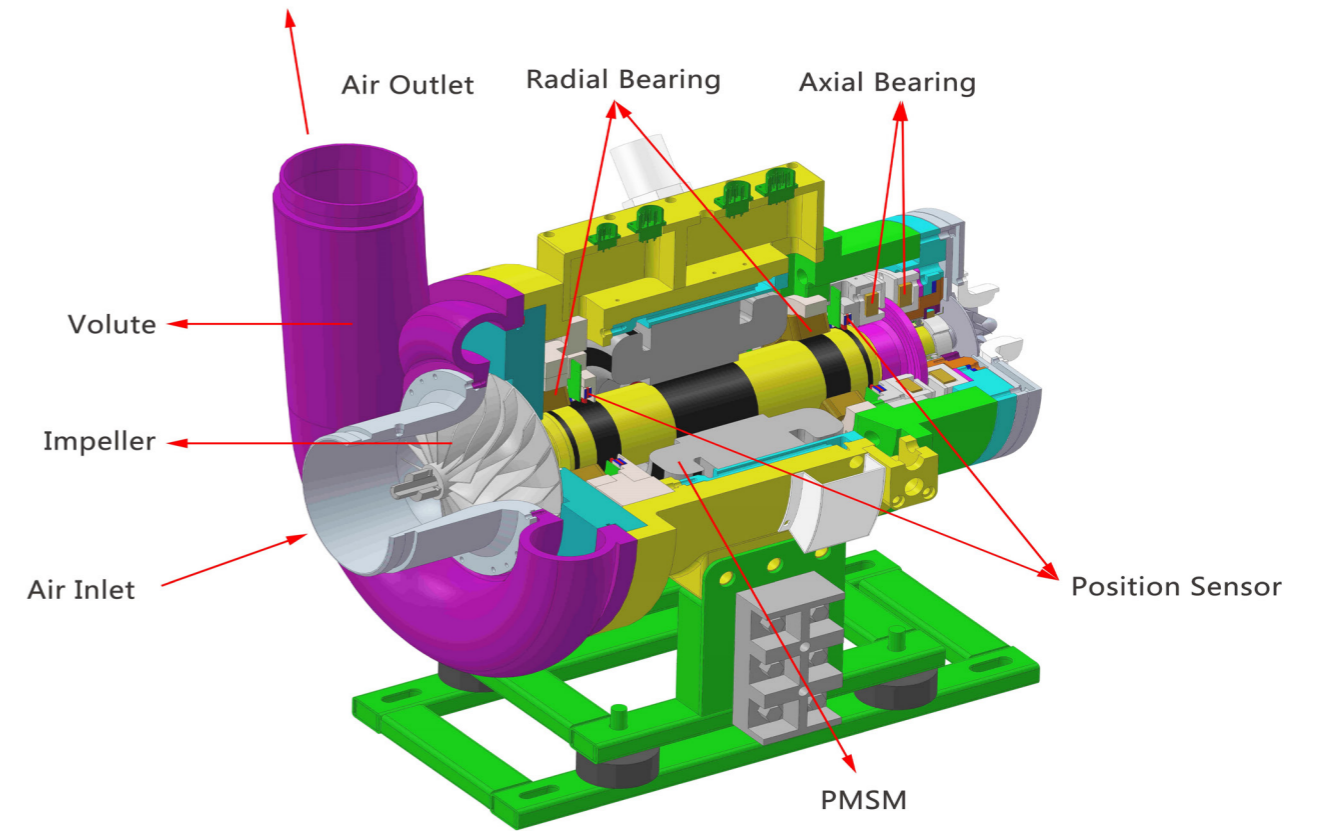

Advantages

Energy saving and high efficiency

Magnetic bearing is adopted, which has no contact loss and mechanical loss, and realizes high-speed stepless speed regulation.

High system integration

It has imported filter, cooling system, automatic anti surge system, power failure and fault protection system, which brings safety, convenience, and reliability of operation.

High cooling efficiency

The cooling system adopts an external condenser, which can effectively protect the fan system and realize the start and stop of the fan at any time.

Oil-free Screw Air Compressor



### Structural design integration

The fan impeller is directly installed at the shaft end of the motor, integrated with the control system, and packaged in the box, with simple and concise structure.

### Magnetic levitation control technology

Signal acquisition and real-time correction more than 10000 times per second, accurate control of rotor axis position, self balancing technology, and the vibration is one order of magnitude smaller than that of traditional bearings.

### Intelligent control

Adjust the speed according to the requirements of the working conditions to realize the adjustment of pressure and flow: the fan has surge prediction and anti-surge functions to save more power for users, better protect the fan, and achieve 100% remote monitoring.

#### Parameter

Model	Pressure (mpa)	Displacement (m <sup>3</sup> /min)	Power (kw)	Dimension (mm)	Weight (kg)	Outlet Size
SB-0.4/15	0.4	11.9	15	2000*1110*1500	1200	DN150
SB-0.6/15	0.6	9.8				
SB-0.8/15	0.8	8.6				
SB-1.0/15	1.0	6.7				
SB-1.2/15	1.2	6.0				
SB-0.4/22	0.4	25.0	22	2000*1110*1500	1200	DN150
SB-0.6/22	0.6	18.0				
SB-0.8/22	0.8	16.5				
SB-0.4/30	0.4	31.5	30	2000*1110*1500	1300	DN150
SB-0.6/30	0.6	26.0				
SB-0.8/30	0.8	22.5				
SB-1.0/30	1.0	16.5	37	2750*1690*1800	2200	DN200
SB-0.4/37	0.4	40.0				
SB-0.6/37	0.6	32.0				
SB-0.8/37	0.8	26.5				
SB-1.0/37	1.0	23.5				
SB-1.2/37	1.2	19.0	1400	2750*1690*1800	1400	DN150
SB-1.5/37	1.5	16.0				

Model	Pressure (mpa)	Displacement (m <sup>3</sup> /min)	Power (kw)	Dimension (mm)	Weight (kg)	Outlet Size
SB-0.4/45	0.4	48.5	45	2750*1690*1800	2400	DN200
SB-0.6/45	0.6	37.0				
SB-0.8/45	0.8	31.5				
SB-1.0/45	1.0	25.5				
SB-1.2/45	1.2	23.8				
SB-1.5/45	1.5	20.5	55	2750*1690*1800	1800	DN150
SB-0.4/55	0.4	60.0				
SB-0.6/55	0.6	51.5				
SB-0.8/55	0.8	40.0				
SB-1.0/55	1.0	34.0				
SB-1.2/55	1.2	30.5	75	2750*1690*1800	2900	DN200
SB-1.5/55	1.5	25.5				
SB-0.4/75	0.4	78.0				
SB-0.6/75	0.6	67.0				
SB-0.8/75	0.8	56.0				
SB-1.0/75	1.0	50.0	90	2750*1690*1800	3000	DN300
SB-1.2/75	1.2	42.0				
SB-1.5/75	1.5	32.0				
SB-0.4/90	0.4	95.0				
SB-0.6/90	0.6	78.0				
SB-0.8/90	0.8	67.0	110	3100*1775*2200	3200	DN300
SB-1.0/90	1.0	58.0				
SB-1.2/90	1.2	50.0				
SB-1.5/90	1.5	43.0				
SB-0.4/110	0.4	108.0				
SB-0.6/110	0.6	100.0	132	3100*1775*2200	3300	DN300
SB-0.8/110	0.8	83.0				
SB-1.0/110	1.0	77.0				
SB-1.2/110	1.2	61.5				
SB-1.5/110	1.5	50.0				
SB-0.4/132	0.4	100.0	160	3100*1775*2200	3800	DN300
SB-0.6/132	0.6	89.0				
SB-1.2/132	1.2	76.0				
SB-1.5/132	1.5	60.0				
SB-1.0/160	1.0	100.0				
SB-1.2/160	1.2	98.0	185	3100*1775*2200	4000	DN300
SB-1.5/160	1.5	76.0				
SB-1.5/185	1.5	88.0	200	3100*1775*2200	4200	DN300
SB-1.5/200	1.5	98.0				





**Oil Free Turbo Air Compressor**



**Features**

**01**

The air system is cleaner without oil and carbon pollution.

**02**

Few moving parts, simple structure, high reliability, and long service life.

**03**

There is no need to replace the lubricating oil and its oil filter, it is more environmentally friendly.

**04**

During operation, the dynamic and static scroll plates do not contact, with low vibration and lower noise.

**05**

Almost no wearing parts, little maintenance workload and lower maintenance cost.

**06**

The multi machine compound intelligent control mode adjusts the compressed air consumption.

**Parameter**

Model	Pressure (mpa)	Displacement (m <sup>3</sup> /min)	Power (kw)	No Of Air End	Dimension (mm)	Weight (kg)
SS-0.75/2.2	0.75	0.25	2.2	1	840*780*1066	230
SS-0.85/2.2	0.85	0.24				
SS-1.05/2.2	1.05	0.22				
SS-0.75/3.7	0.75	0.40	3.7	1	840*780*1066	230
SS-0.85/3.7	0.85	0.39				
SS-1.05/3.7	1.05	0.37				
SS-0.75/5.5	0.75	0.51	5.5	2	930*1200*1230	360
SS-0.85/5.5	0.85	0.48				
SS-1.05/5.5	1.05	0.44				
SS-0.75/7.5	0.75	0.80	7.5	2	930*1200*1230	360
SS-0.85/7.5	0.85	0.78				
SS-1.05/7.5	1.05	0.74				
SS-0.75/11	0.75	1.20	11	3	1400*910*1320	500
SS-0.85/11	0.85	1.17				
SS-1.05/11	1.05	1.11				
SS-0.75/15	0.75	1.60	15	4	1930*1270*1340	720
SS-0.85/15	0.85	1.56				
SS-1.05/15	1.05	1.47				
SS-0.75/18.5	0.75	2.00	18.5	5	1930*1270*1340	860
SS-0.85/18.5	0.85	1.95				
SS-1.05/18.5	1.05	1.84				
SS-0.75/22	0.75	2.40	22	6	1930*1270*1340	900
SS-0.85/22	0.85	2.34				
SS-1.05/22	1.05	2.21				
SS-0.75/30	0.75	3.20	30	8	2030*1260*2100	1200
SS-0.85/30	0.85	3.12				
SS-1.05/30	1.05	2.95				
SS-0.75/37	0.75	4.00	37	10	2030*1260*2100	1420
SS-0.85/37	0.85	3.89				
SS-1.05/37	1.05	3.68				

1. Displacement in accordance with ISO 1217 : 2009.

2. Noise level as per ISO 2151 and the basic standard ISO 9614-2, operation at maximum operating pressure and maximum speed; tolerance: ± 3 dB(A).

Notice: Specifications are subject to change without notice.

Oil-free Screw Air Compressor

### Installation of main circuit cable of screw air compressor:

1. The correctness of power supply voltage of air compressor shall be ensured.
2. Select the appropriate black air switch according to the power of the air compressor and use the power control.
3. The incoming line of low-voltage power supply must be installed with standard fuse and isolating air switch, which shall be installed close to the air compressor and easy to access and control.
4. The cable shall not have too much stress during installation, to avoid short circuit caused by cable loosening in the future.
5. The cable shall not contact with the metal block mouth to avoid short circuit caused by cable cutting in the future.

### Installation of cooling water pipe of screw air compressor:

1. Sufficient flow and lift shall be considered in the selection of water pump.
2. Avoid using deep well water and chilled water for cooling water, because the water quality of deep well water is very hard.
3. The supply pressure of cooling water shall be 3.0-5.0bar, and the pressure difference between inlet and return water shall be > 1.5bar.
4. The cooling water inlet pipe shall be equipped with filter screen.
5. The maximum inlet temperature of cooling water for screw air compressor is 35 °C . Generally, cooling tower is required for cooling water system.
6. Blowdown valve shall be installed at the end of cooling water supply pipeline.
7. The customer shall regularly test the screw air compressor. If the water quality fails to meet the requirements, the cooling water must be treated with water treatment method until the water quality meets the standard.

### Layout and placement of variable speed screw air compressor room

1. Installation ground: the ground is flat and can bear the dead weight of the air compressor.
2. Noise reduction and vibration reduction: if necessary, a piece of rubber can be padded on the base of the air compressor to reduce vibration and noise.
3. Installation spacing: the distance between the variable speed screw air compressor and the surrounding objects shall not be less than 1m, and the daylighting and lighting conditions shall be good for operation and maintenance.
4. Traveling crane equipment: for air compressors above 75kW, it is recommended to install traveling crane in the air compressor station building to facilitate maintenance.
5. Placement of air storage tank: an air storage tank shall be installed behind the air compressor. The volume of the air storage tank shall be more than 20% of the exhaust volume of the air compressor per minute, and personnel shall be arranged to drain water regularly.

### What should the screw air compressor be checked regularly?

1. The oil level in the oil-gas separator. Remember to check during operation, because all the oil returns to the original position during shutdown. If the oil level is too low, add lubricating oil. When refueling, stop the machine first and loosen the refueling plug for refueling after pressure relief.
2. The integrity of the hose. Whether there is leakage.
3. All electrical connectors shall be stable and in good condition.
4. Water gas separator, ball valve, screw unit, automatic discharge of condensate.
5. The exhaust temperature shall be within the specified value of 75 ~ 95 °C .
6. Check and record voltage, current, exhaust pressure, exhaust temperature, oil level, etc. regularly during operation.
7. Whether the pressure switch works normally, whether the compressor is unloaded when the working pressure is at the upper limit and loaded when the working pressure is at the lower limit.
8. Close the door of the acoustic enclosure after inspection.



## Daily maintenance of screw air compressor

1. Daily work content: check the compressor oil level; Check the readings on the display screen and instrument panel; Check whether there is condensate discharge during loading: after shutdown, please discharge the condensate in the air and aftercooler:
2. Weekly work content: check the setting value in the program; If an air reservoir is installed, drain the condensate; Check for possible leaks.
3. Work content every six months: remove the air filter, clean and check for damage by injecting high-pressure air: clean the compressor.
4. Annual work content: replace the gearbox ventilation filter element; Conduct indicator / display test; Replace the oil filter; If mineral oil is used, change the oil; Replace the air filter; Test the relief valve.

## Common faults and Solutions

1. Water content in lubricating oil of oil injected screw air compressor: unload the machine for a long time, adjust the air consumption, integrated screw air compressor, and increase the loading time of air compressor; Thermostatic valve failure, thermostatic valve maintenance or replacement; If the temperature of cooling water is too low, avoid using chilled water; If the water cooler leaks, repair or replace the water cooler.
2. High oil content at the air end outlet: if the oil level is too high, put the oil to the standard height; If the oil temperature is too high, check the temperature control valve, cooling water, cooling water pressure and oil cooling efficiency of the integrated screw air compressor; The 2mm small hole of the oil return pipe is blocked and dredged; If the oil return pipe is bent or deviated, adjust or replace the oil return pipe; If the oil-gas separator is damaged, replace the oil-gas separator.

## Customer Case

